

# ZENITH VERSATILE QUICK CLAMP

MACHINE TOOL PRODUCT

THE MOST FLEXIBLE CLAMP IN THE INDUSTRY



- **Type of Product:**

Swivel Clamp Base with Toggle Clamps. These swivel clamp bases are capable of providing 360 degree rotation, which eliminates multi-mounting of clamps and gives ease/versatility in tight situations. The sliding base also gives flexibility to reach different and difficult access areas.

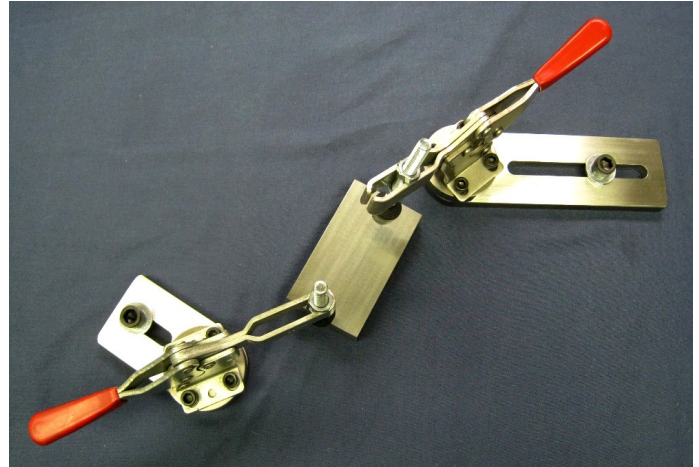
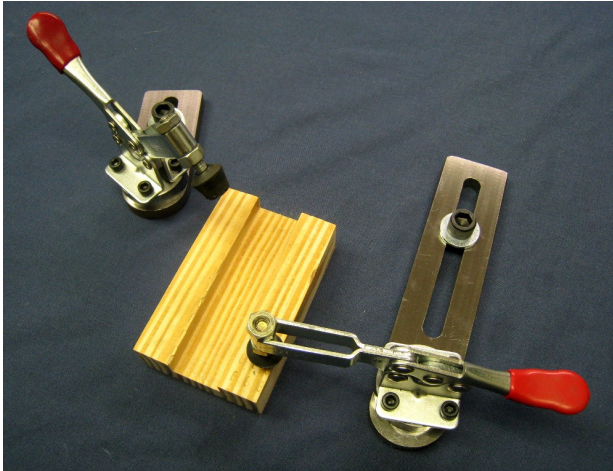

- **Holding characteristics:**

The clamps are designed in different sizes capable to provide holding forces of 150 lbs. to 500 lbs. The easy mechanism allows the operators to clamp and to release the part in a jiffy, focusing on lean manufacturing.

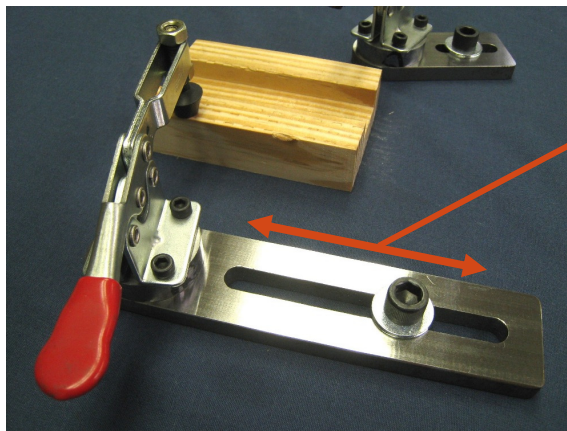

Sliding capability

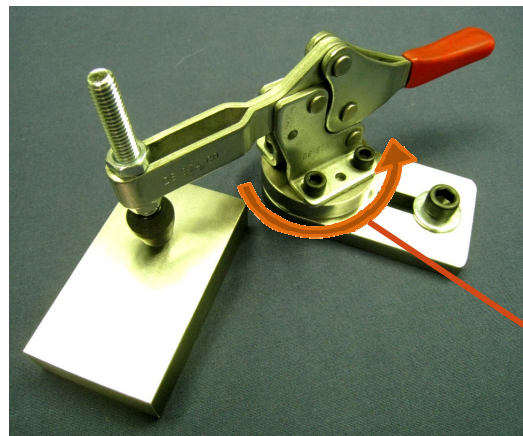

Swivel 360°

- **Typical Applications:**

Machine shops or production, CNC machine beds, woodworking, welding, metal cutting, deburring operations, assembly fixtures, tooling components or any application that requires quick and easy clamping.

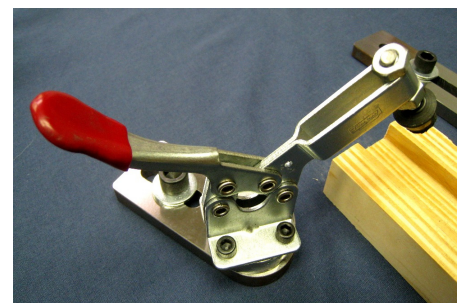

## EXAMPLE — MACHINING APPLICATION

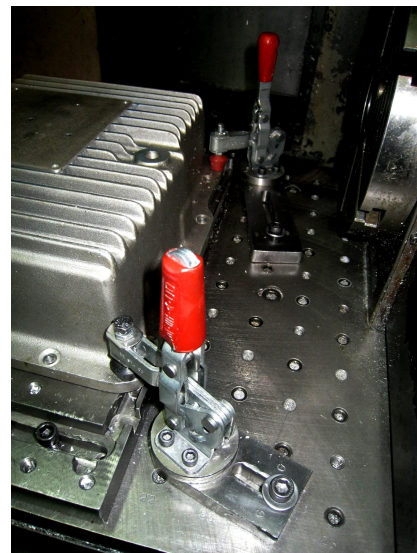
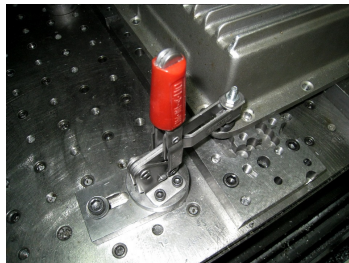
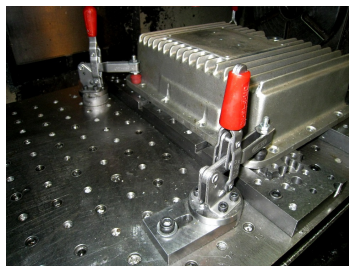
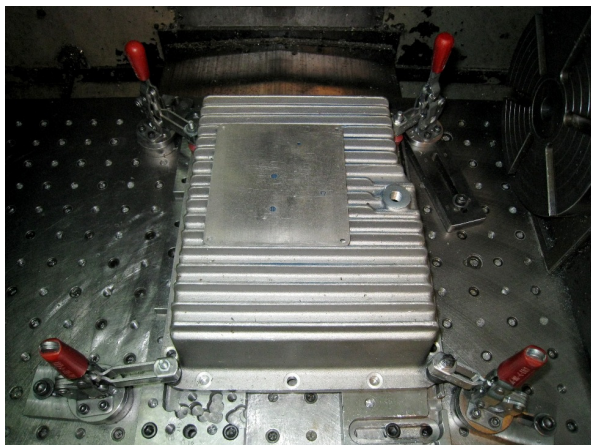

### ZENITH VERSATILE QUICK CLAMP - Dimension & Sizes

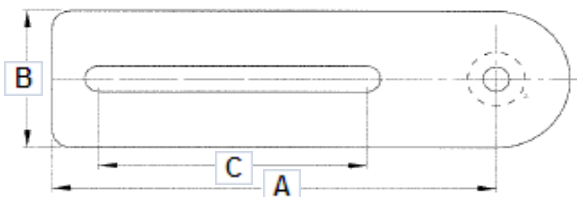

Part #	Clamping Force (Lbs)	A	B	C
CL-150-3	150	3"	1 1/2"	1 1/8"
CL-500-3	500	3"	2"	1 1/8"
CL-150-6	150	6"	1 1/2"	3 5/8"
CL-500-6	500	6"	2"	3 5/8"

*\* CUSTOM SIZES AVAILABLE*

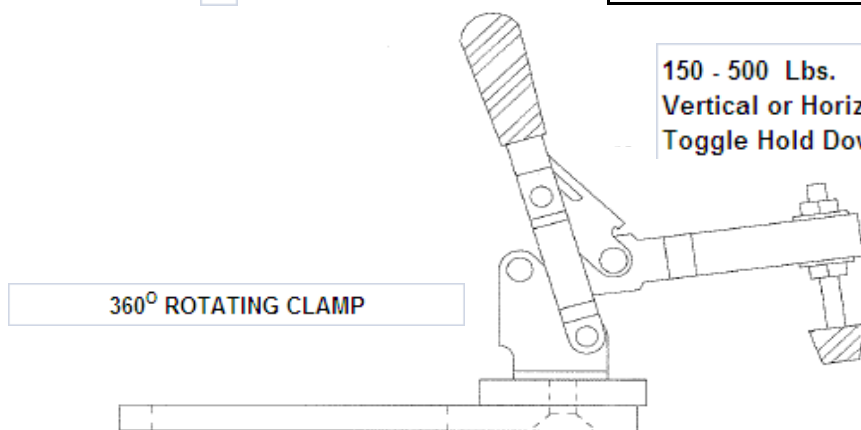

150 - 500 Lbs.  
Vertical or Horizontal  
Toggle Hold Down Clamps

### ZENITH VERSATILE QUICK CLAMP - Price list

Part #	"A" Length	0 – 15 pcs.	15 + pcs.
CL-150-3	3"	\$ 30.49	\$ 28.49
CL-500-3	3"	\$ 35.89	\$ 33.89
CL-150-6	6"	\$ 31.49	\$ 29.49
CL-500-6	6"	\$ 38.89	\$ 36.89

**CONTACT US FOR MORE INFORMATION OR ORDERING :**

Chet Zinnanti — phone (276) 645-8616  
Or email: [czinnanti@zenithfuelsystems.com](mailto:czinnanti@zenithfuelsystems.com)